



INSTALLATION MANUAL

MIRAGE RESIDENTIAL AWNING

110V MOTORIZED LATERAL ARM BOX AWNING

Residential



Read this manual before installing or using this product. Failure to follow the instructions and safety precautions in this manual can result in personal injury and/or cause the product to not operate properly.

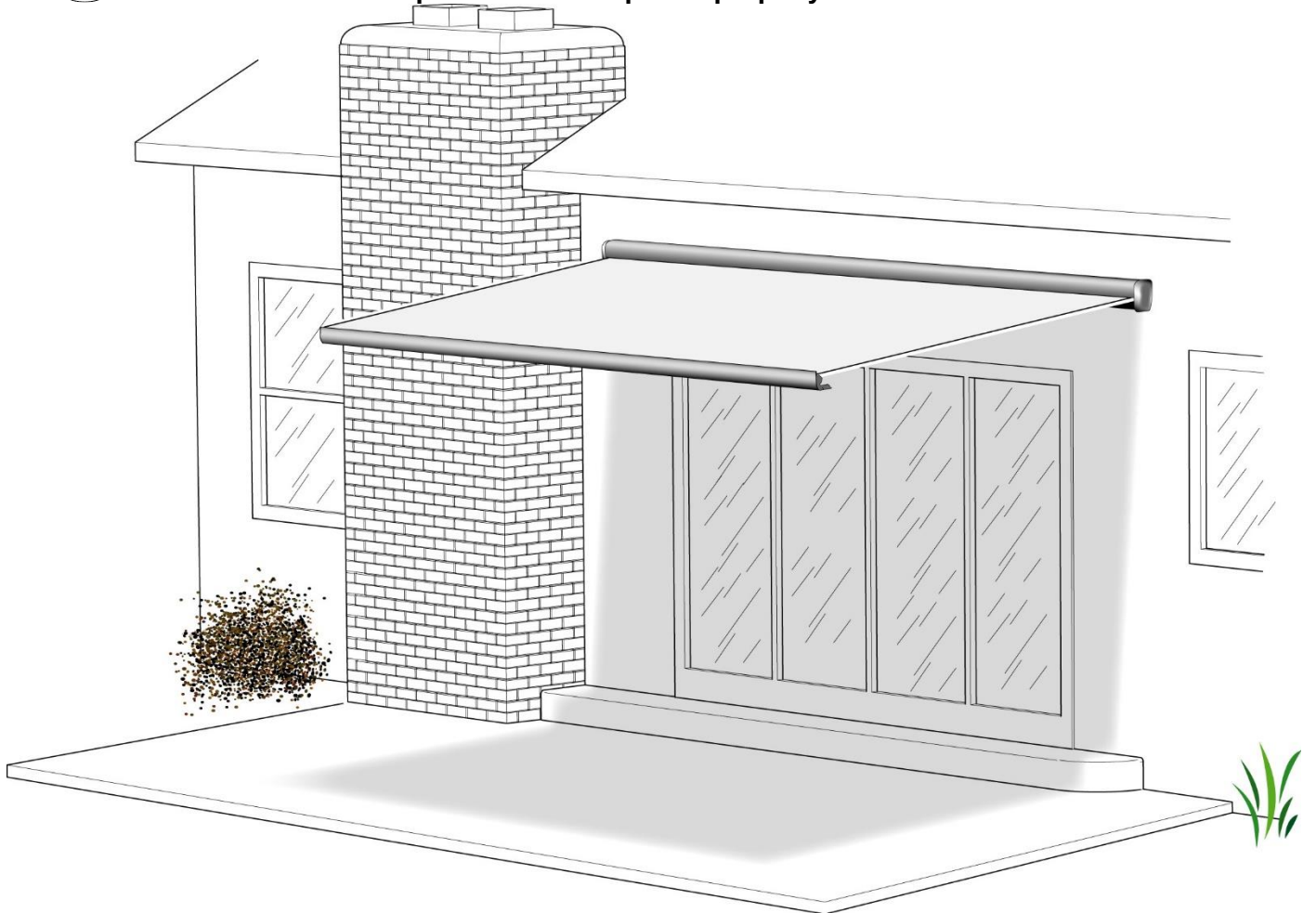

TABLE OF CONTENTS

Product Overview	4
Component Check list.....	5
Installation	6
Required Pre-Installation Parameters	6
Mounting Plate Layout and Installation	6
Attaching the Mounting Plate	7
Mounting the Awning	8
Securing the Awning.....	10
Setting the Operational Parameters.....	10
Optional LED Lighting.....	12
Pitch Adjustment.....	13
Manual Override	13

PROPRIETARY STATEMENT

The Mirage WM Awning is a product of SOL-LUX, located in Broomfield, Colorado, USA. The information contained in or disclosed in this document is considered proprietary to SOL-LUX. Every effort has been made to ensure that the information presented in the document is accurate and complete. However, SOL-LUX assumes no liability for errors or for any damages that result from the use of this document.

The information contained in this manual pertains to the current configuration of the models listed on the title page. Earlier model configurations may differ from the information given. SOL-LUX reserves the right to cancel, change, alter or add any parts and assemblies described in this manual, without prior notice.

SOL-LUX agrees to allow the reproduction of this document for use with SOL-LUX products only. Any other reproduction or translation of this document in whole or part is strictly prohibited without prior written approval from SOL-LUX.

SAFETY INFORMATION



This is the safety alert symbol. It is used to alert individuals to potential personal injury hazards. Obey all safety messages that follow this symbol to avoid possible personal injury or death.



Indicates a hazardous situation, which if not avoided, could result in death or serious bodily injury.



Indicates a hazardous situation, which if not avoided, may result in minor or moderate bodily injury.



Indicates a situation that may result in equipment-related damage.

General Safety:



This product can expose you to chemicals including Di-isodecyl phthalate (DIDP), Vinyl Chloride and Formaldehyde, which are known to the state of California to cause cancer or birth defects or other reproductive harm. For more information visit www.P65warnings.ca.gov



The Mirage awning is built with a wind sensor. During vibration and movement of the awning in the open position, if the sensor detects enough movement it will instruct the motor to automatically retract the awning. However, wind is variable, and a strong gust of wind can occur faster than the sensor can react and the wind can quickly damage the awning, potentially breaking loose from the mounting plate. An unsecured awning striking a person may result in injury or death. Do not leave the awning unsupervised at any time. You should immediately retract the awning if wind is starting to affect the awning in an unsafe manner.



The Mirage motorized awning has spring loaded arms which push the awning open. The motor and the canopy resist the spring-loaded opening action. Extreme care must be taken when working with the awning to prevent the unintentional release of the spring-loaded arms. Do not stand on a ladder in front of the awning if it is unsecured when performing repairs or maintenance. You must secure the awning first by tying the arms together or looping a retaining strap of sufficient strength around the case and leadrail to prevent an unintentional full release of the awning.



Shock Hazard. Always disconnect battery or power source before working on or around the electrical system.



Always wear appropriate safety equipment (i.e. goggles) during installation or maintenance.



Always use appropriate lifting devices and/or helpers when lifting or holding heavy objects.

NOTICE When using fasteners, do not over tighten. Soft materials such as fiberglass and aluminum can be "stripped out" and lose the ability to grip and hold.

PRODUCT OVERVIEW

The Mirage Awning is a state of the art lateral arm awning. When retracted, the housing provides protection against the elements while the streamlined styling blends in with the house. The full tension canopy fabric allows the awning to be partially or fully extended for best shade coverage.

Each unit is equipped with lateral support arms.

Mirage Awning Specifications:

- Fully retractable and self storing;
- The sealed awning motor operates on standard 110VAC;
- Case and frame are constructed of high-strength aluminum extrusions, protected with a polyester paint finish;
- Stainless steel fasteners and hardware.

SPECIFICATIONS

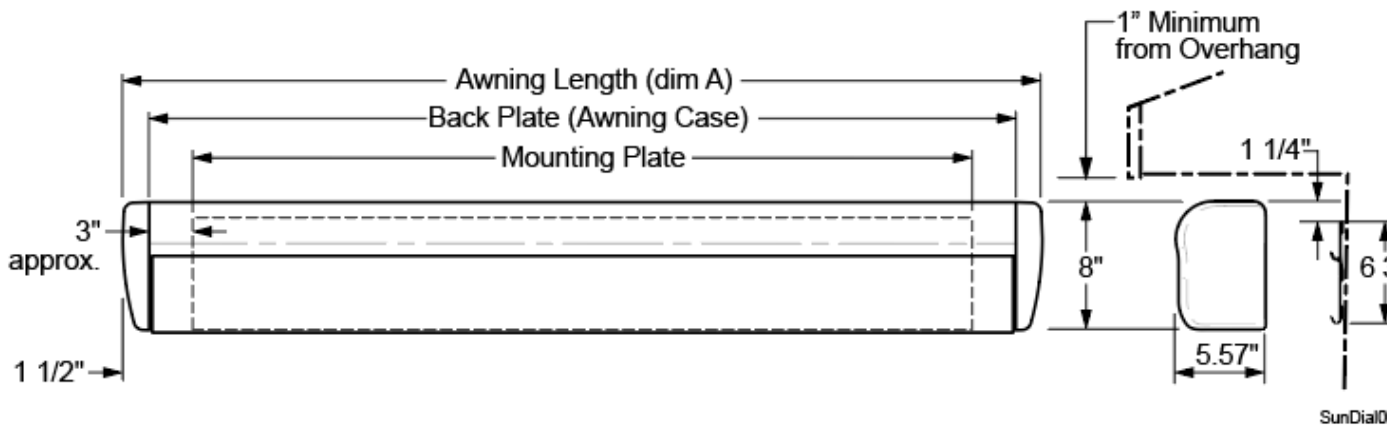

Figure 1

LENGTH (DIM A):	feet	14.5	15	16	17	18	19	20	21
APPROX WEIGHT:	LBS.	162	170	179	187	196	204	213	221
EXTENSION:	Inches	144							
POSITION CONTROL:	120V Motorized w/ tubular motor								
CONTROLLER:	Standard: –Somfy Awning Controls								

MOTOR SPECIFICATIONS

<i>Motor Type:</i>	Tubular
<i>Power:</i>	120v, 60Hz, 2.1Amps
	<i>Torque: 50Nm</i>
<i>Speed</i>	14 rpm

COLORS AVAILABLE

<i>Case</i>	White or Black
<i>Fabric:</i>	Acrylic – Please contact Carefree for color availability

OPERATION PARAMETERS

<i>Wind Sensor</i>	Please refer to Somfy Eolis 3D Wirefree RTS instructions 5050583D,5050585D,5052575D
<i>Remote</i>	Please refer to Somfy Situo 1/5 Soliris RTS II instructions 5151626B
<i>Safety Instructions</i>	Please refer to Somfy Safety instructions 5160994A, 5160996A, 5117827B
<i>Motor Instructions</i>	Please refer to Somfy motor instructions 5063073C
<i>LED Receiver</i>	Please refer to Somfy Dimmable LED RTS light kit instructions

COMPONENT CHECK LIST

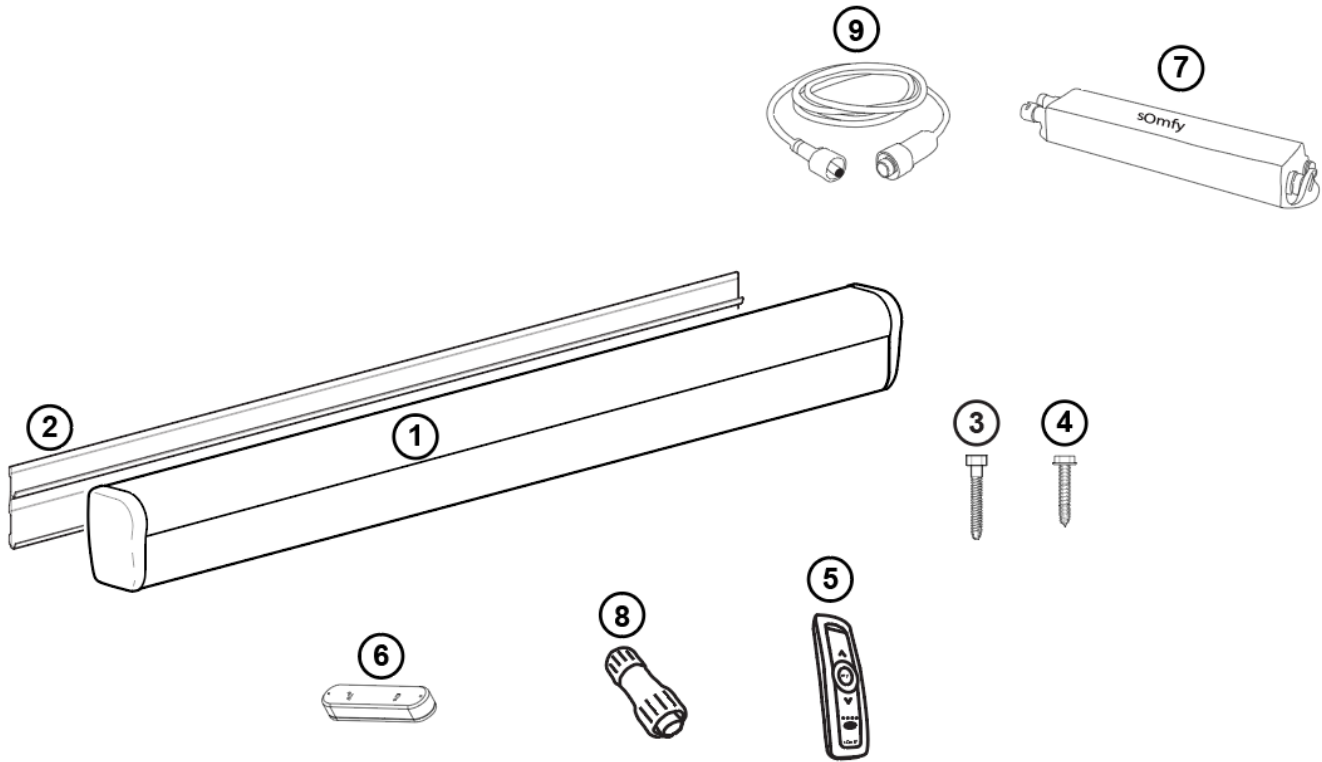

Figure 2

MR003

<input checked="" type="checkbox"/>	ITEM	DESCRIPTION		QTY	NOTE
<input type="checkbox"/>	1	Awning Assembly		1	1
<input type="checkbox"/>	2	Mounting Plate		1	2
<input type="checkbox"/>	3	Screw, Lag (Not included)	3/8" x 3"	NOTE	3
<input type="checkbox"/>	4	Screw, Lag	1/4" x 1 1/2"	3	3
<input type="checkbox"/>	5	Somfy Awning Remote		1	4
<input type="checkbox"/>	6	Somfy Wind Sensor (located inside the awning)		1	5
<input type="checkbox"/>	7	Somfy Dimmable LED Receiver RTS		1	6
<input type="checkbox"/>	8	Somfy 2 Pole Plug, 12V DC LEDs		1	6
<input type="checkbox"/>	9	Somfy Extension Cable		1	6

- NOTES:
- Awning configuration is specified at time of order, including awning length, fabric etc. Check awning assembly against original purchase order.
 - Mounting Plate is provided with the awning. Do not modify the length of the mounting plate.
 - Purchase appropriate fastener for your installation, not provided. Follow instructions based on awning length for the proper quantity of fasteners.
 - Two styles of Somfy remotes are available. Interior rated remote and Exterior rated remote. Either remote can operate the awning. Remote style is specified at time of purchase.
 - All Mirage awnings are supplied with a Somfy Wind Sensor standard, which is paired to the motor prior to shipment.
 - Items 7,8,9 are standard features on all Mirage awnings

INSTALLATION

For structural and operation integrity, the Mirage WM awning must be mounted with the included mounting plates and cannot be mounted using an awning rail.

Prior to mounting the awning, ensure that the awning will not interfere with light fixtures, exhaust vents, openings, etc.

REQUIRED PRE-INSTALLATION PARAMETERS

Prior to installing the awning, the installer must determine the layout of the specific construction elements to successfully assemble and mount the awning.

1. Determine the location, size and type of structural framing in the area where the awning is to be mounted.
 - There must be structural framing at the awning mount locations. Fiberglass or sheet metal siding alone is **NOT** strong enough to support the weight of the awning!
 - If the framing is not obvious, it may be possible to use a stud finder or other similar device.
 - If in doubt, contact an engineer or contractor to determine the type and position of the structural frame.
2. Determine the mounting locations for the power supply/LED driver.
 - The power supply should be mounted in accordance with the authority having jurisdiction wiring requirements for outdoor electrical appliances.

MOUNTING PLATE LAYOUT AND INSTALLATION

1. Determine the location of the awning:
 - General profile dimensions are shown in Figure 1
 - Mounting area must be plumb and clear of obstacles;
 - The mounting plate is 7 1/2" shorter than the awning; 6" shorter than the back plate. (Reference Figure 1). Do not modify the length of the mounting plate.
 - The awning is factory set with minimum pitch. Mounting height above a door opening or window must be adjusted if a greater pitch is desired. The chart below provides the minimum distance from the top of a protrusion to the bottom of the mounting plate when the awning is set at MINIMUM and MAXIMUM pitch:

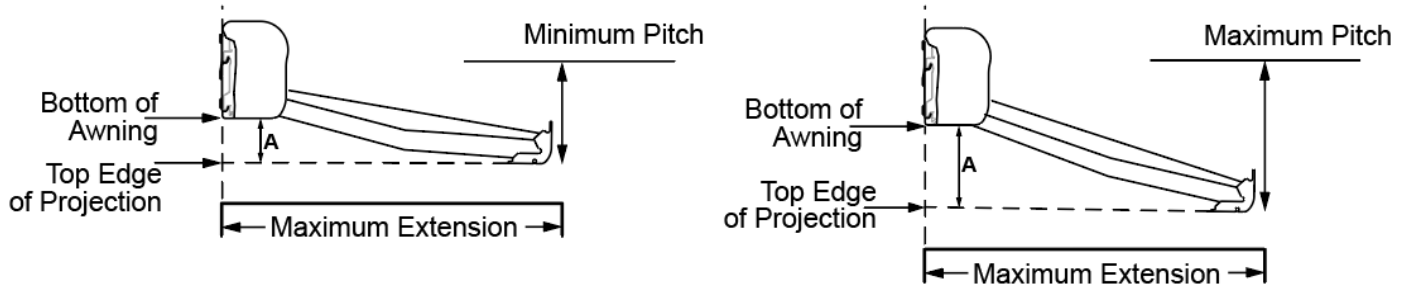

MR006

Figure 3

Awning Length	15ft to 21ft
A @ MIN PITCH AND MAX EXTENSION	Approximately 24.5 inches
A @ MAX PITCH AND MAX EXTENSION	Approximately 50.5 inches

2. Mark the mounting plate position with a chalk line ensuring that it is parallel to the ground. Include the end points of the mounting plate.
3. Use a non-permanent method of marking to temporarily mark the location of the structural framing in the mounting area.
4. Transfer the frame pattern to the mounting plate.
5. Below is the minimum number of required mounting locations. Each location uses two screws.

Awning Length	14.5ft	15ft	16ft	17ft	18ft	19ft	20ft	21ft
# of Locations	6				7			

6. On the plate mark the location of the mounting locations. The inner mounting locations should be spaced as evenly as possible between the outer mounting locations. Locations must match the frame location pattern. If using the optional roof top mounting brackets, adjust the pattern to match the bracket mounting holes.
7. Position the mounting plate on the wall using the marks made previously.
8. Determine the best method to attach the plate to the wall. Examples for attaching are shown below. Bracket attach details are suggestions and may not cover all circumstances. If unsure, consult a builder or engineer prior to installation.

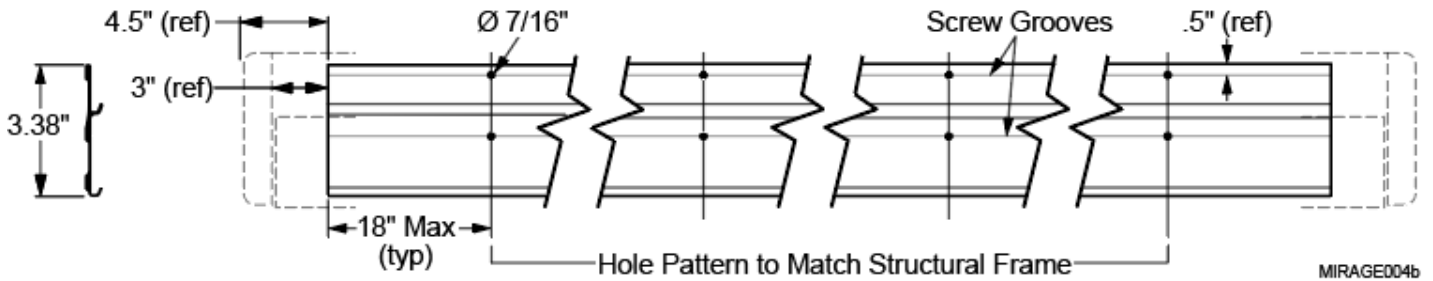

9. **⚠ WARNING** The mounting plate **MUST** be secured to the structural frame on both sides of the Case Connectors inside the awning, or directly behind the Case Connectors. If not, damage over time to the mounting plate will occur, possibly resulting in detachment of the awning from the mounting plate. The Case Connector location can be easily seen when visually inspecting the awning in the closed position. There are 2 screws on the outside of the awning at the location of the Case Connector. If installing the mounting plate to a header board, there is potential for the Awning to bend the mounting plate or header board over time if the case connectors are not directly in line with the structural framing. Additional engineering may be required when using a header board.

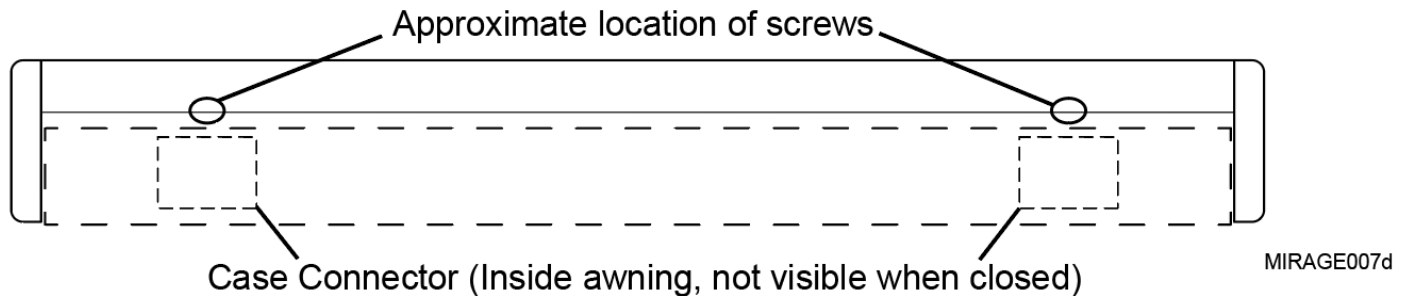

ATTACHING THE MOUNTING PLATE

1. Determine the optimum positioning of the awning.
 1. The centerline of the awning fabric is offset from the centerline of the awning assembly. To align the center of the fabric, use the backplate of the awning assembly for measurements.
 2. The bottom of the mounting plate should be 11" above any openings or frames to avoid interference when the awning is installed. Dimensions are based on the steepest pitch. The height can be reduced by reducing the pitch.
 3. Measure each end of the awning position from the ground so that the awning is mounted parallel to the ground.

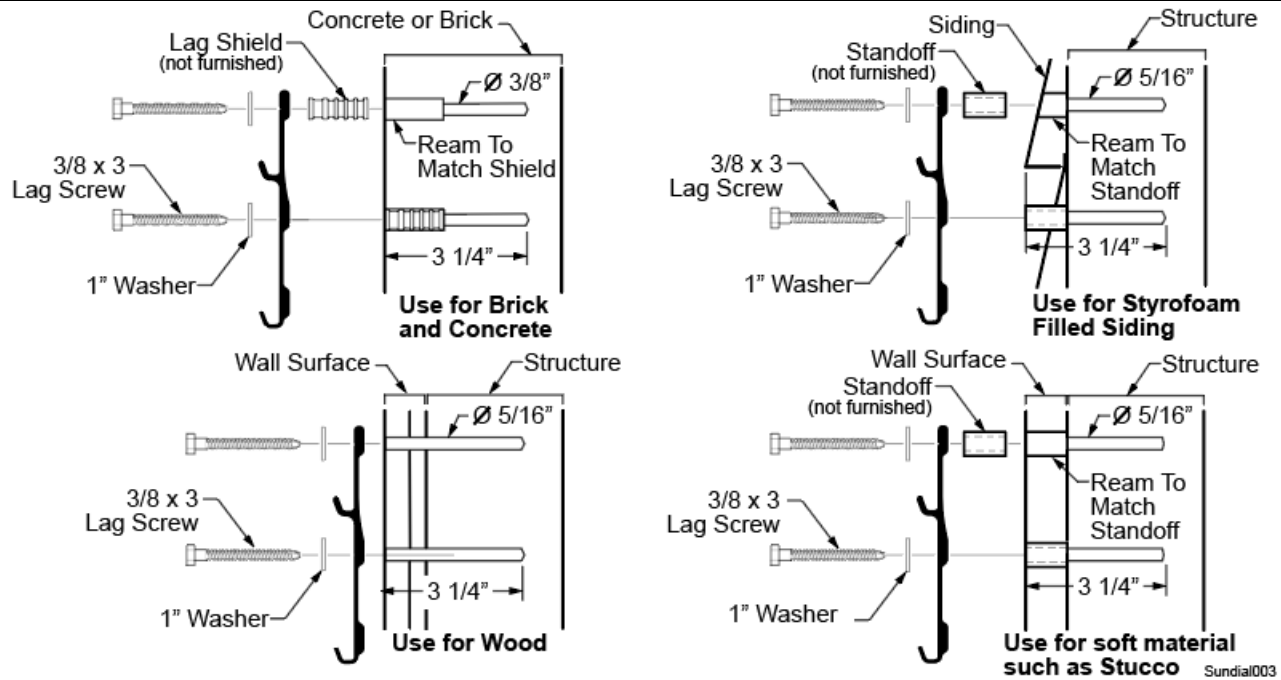

Figure 4

4. Determine where to drill through the mounting plate. Identify structural materials for anchoring the mounting plate.
5. The lag screws can be used for mounting into wood or aluminum frames.
 - 5.1. Using the plates as a template, drill $3/32$ " pilot holes for lag screws. You must drill the hole centered in the groove shown in Figure 4.
 - 5.2. Start at the approximate middle of the plate and drill through the top groove into the structural support.
 - 5.3. Drive the lag screw and washer into the structural support, do not tighten all the way.
 - 5.4. Level the mounting plate and drill additional $3/32$ " pilot holes through the mounting plate into the structural support near the ends of the mounting plate.
 - 5.5. Once you confirm the mounting plate is level, firmly drive all required mounting screws to secure the mounting plate.

MOUNTING THE AWNING

! WARNING The Mirage awning is heavy. We recommend a lift with a mechanical advantage to position the awning immediately in front of the mounting plate. Then using at least two (2) people, move the awning into the hooks of the mounting plate.

1. Set the awning into the hooks of the mounting plates.

Route the awning cable through the hole drilled previously while lifting the awning into position.

Tip: If the wire is routed along the back of the case, use small pieces of tape to hold the wire in place while lifting the awning.

2. Adjust the position of the awning horizontally as required.
3. Firmly hold the awning in the brackets and attach the awning case to the brackets using three (3) #6 x $3/8$ inch screws through the bottom of the bracket into the awning case.

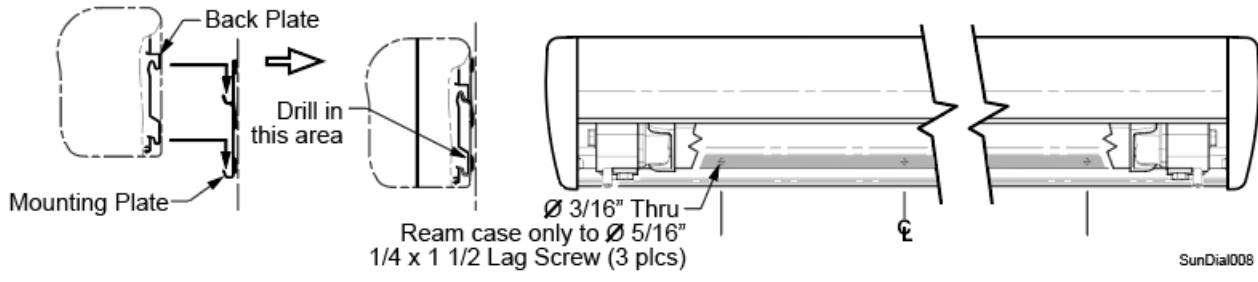

SECURING THE AWNING

The awning must be secured as described below. This step can be done after the wiring is completed and the awning can be opened using the switch or the awning can be opened.

NOTICE For proper awning operation and structural integrity, the awning must be secured as described. Failure to secure the awning may result in damage to the awning and structure and void the warranty.

For the following steps, use the manual override to open the awning or secure the awning after completing the electrical installation.

1. Open the awning approximately 3 feet to access the back panel of the awning case.
2. Drill three (3) 3/16" holes through the case, mounting plate and into wall (do not go through interior surfaces of wall) in the approximate areas shown above.
3. Ream out the holes in the case only to 5/16".

Attach the awning case to the mounting plate and wall using three (3) 1/4 x 1 1/2 lag screws.

SETTING THE OPERATIONAL PARAMETERS

Once the awning is properly secured, you may start to utilize the Somfy controllers to set up the operational parameters for the awning. There are 3 phases of this.

- Pairing the Somfy Remote
- Setting the Out Limit
- Setting the In Limit (Optional)
- Setting up the Wind Sensor

1. Connect the 110V motor to the 110V power supply.
2. Verify that the awning is paired to the remote. If not, follow the instructions for the Sunea CMO RTS motor to pair the controller to the awning (Ref 5063073C), section 2.3.1 (Figure 5):

2.3.1. Pre-programming the RTS control point

1) Switch on the power supply.

2) Press the Up and Down buttons on the RTS control point at the same time: The motorised product moves up and down (fast raising and lowering), and the RTS control point is pre-programmed in the motor.

The motorisation is in programming mode for ≈ 10 min.



Figure 5

3. Follow the remaining steps to set the end limits for the awning.

2.3.3. Setting the end limits

Settings for cassette awnings

For cassette awnings, the upper end limit is set automatically, while the lower end limit must be set.

Setting the lower end limit

⚠ Do not use the "my" and Down buttons at the same time to reach the lower end limit.

1) Set the awning to the lower end limit.

⚠ Press and hold the Down button for > 2 seconds to lower the awning in a single movement.

2) Stop the awning in the desired position.

3) If necessary, adjust the position of the awning using the Up and Down buttons..

4) Press the my and Up buttons simultaneously: The awning is raised in one continuous movement even after the my and Up buttons have been released.

5) At the halfway point, briefly press the my button to stop the awning.

6) Press the my button again until the awning makes a movement (1.5 seconds downwards then upwards until the cassette closes): The end limits have been programmed.

Wait for the awning to stop completely before going to the chapter "Programming the first RTS control point."

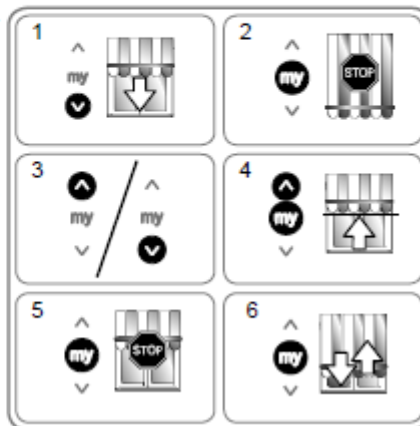
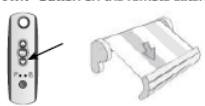

Figure 6

4. Follow the remaining instructions for other various functions with the Somfy Autonomous Awning controls. Some important sections of the manual to aid the installer are as follows:
 - a. Section 2.3.2, Checking the rotation direction
 - b. Section 2.3.8, Closing Force Function
5. Pair the Eolis 3D Wirefree RTS wind sensor to the motor
 - a. Follow the instructions to program the wind sensor to the motor (Ref 5050583D)

Eolis 3D WireFree™ Quick Reference Guide

STEP 1
Make sure the "DOWN" button on the remote extends the awning.



STEP 2
Slide the mounting plate off the 3D housing. With the awning extended, install the mounting plate using the preferred method suggested by the awning manufacturer.

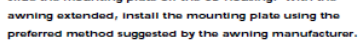

STEP 3
Remove the sensor housing using a small screwdriver.

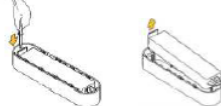

STEP 4
Install the batteries. Make sure the red light blinks.



STEP 5
Press the programming button on the back of the remote until the awning jogs.



STEP 6
Press the programming button on the 3D until the awning jogs again.

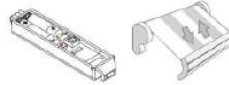

STEP 7
Put the sensor electronics back in the housing.



STEP 8
Slide the housing back on the mounting plate.



STEP 9
Test the sensor by pushing up and down on the awning front bar or arm until it begins to retract. You can use the remote to stop the awning after 5 seconds (first test mode).



STEP 10
Bring it back out and test it again. You can use the remote to stop the awning after 5 seconds (second test mode).



STEP 11
Make adjustments to the sensitivity if needed and test it again.

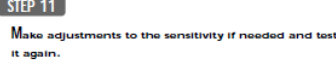

MADE IN CHINA BY **somfy.**

OPTIONAL LED LIGHTING

The Mirage awning is available with LED lighting. The LED is connected to the Dimmable LED RTS light kit, which also provides power to the motor. One Dimmable LED RTS light kit will operate the awning motor and the LED lights.

PITCH ADJUSTMENT

NOTICE During installation or when the pitch of the awning is adjusted, it is important that the leadrail is parallel to the awning housing.

1. Extend the awning fully.

To Lower the Pitch:

2. SLIGHTLY loosen the M12 hex screw on the side of the knuckle.
3. On the front of arm knuckle turn the M12 hex screw COUNTERCLOCKWISE to lower the pitch.
4. Tighten the M12 setscrew until snug.

To Raise the Pitch:

5. SLIGHTLY loosen the M12 hex screw on the side of the knuckle.
6. Loosen the M12 set screw several rotations.
7. On the front of arm knuckle turn the M12 hex screw CLOCKWISE to raise the pitch.

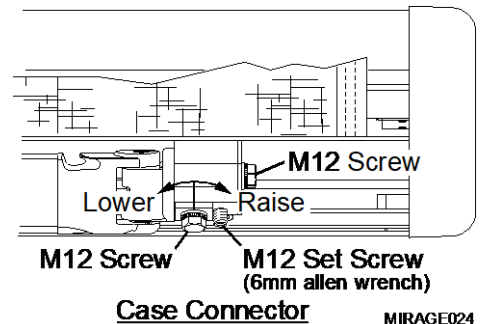

NOTE: When raising the pitch, it is helpful to have a second person lift up on the lead rail.

8. Tighten the M12 set screw until snug.
9. Repeat steps 5 through 8 for the other end.
10. When the pitch adjustments are completed, tighten the M12 screws on the side of the knuckle.

When the pitch is adjusted, it is necessary to adjust the angle of the lead rail for the awning to close correctly.

11. SLIGHTLY loosen the M12 nut on the side of each arm knuckle on the lead rail.
12. Turn the M12 setscrews of each knuckle to increase or decrease the angle of the lead rail. The bottom of the lead rail should be parallel with the ground.
13. When the lead rail adjustments are completed, tighten the nut on the side of the knuckles.

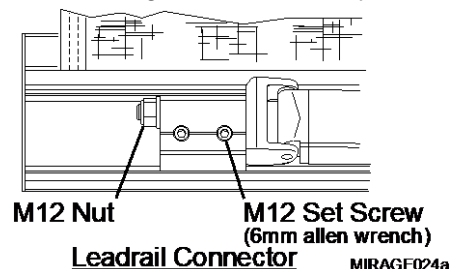

MANUAL OVERRIDE

If 110V power is not available to the awning, the Mirage awning can still be safely retracted using the manual override. The bypass may be accessed from inside the case on the motor housing or from the top of the case above the motor housing.

To use the inside bottom access: The awning must be open a minimum of 8" to afford access to the override.

To use the top bypass access: Remove the screw and well nut that is used to secure the end cap.

1. Chuck the 7mm hex key into a 3/8" battery powered drill.
2. Insert the hex key into the manual override on the awning. For the top access, it will be necessary to locate the hex by feel; it is not visible with the key inserted in the hole.
3. Operate the drill in the forward (clockwise) direction to close the awning. Reverse the drill to open the awning.

NOTE: When using the bottom override, the awning can only be closed within 6-8". It will be necessary to use the top access to close the awning completely.

4. When done, return the screw and well nut to the top of the case if removed.

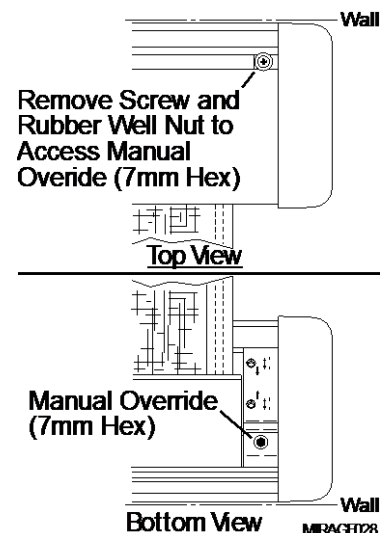

MOUNTING TEMPLATE 1:1 SCALE

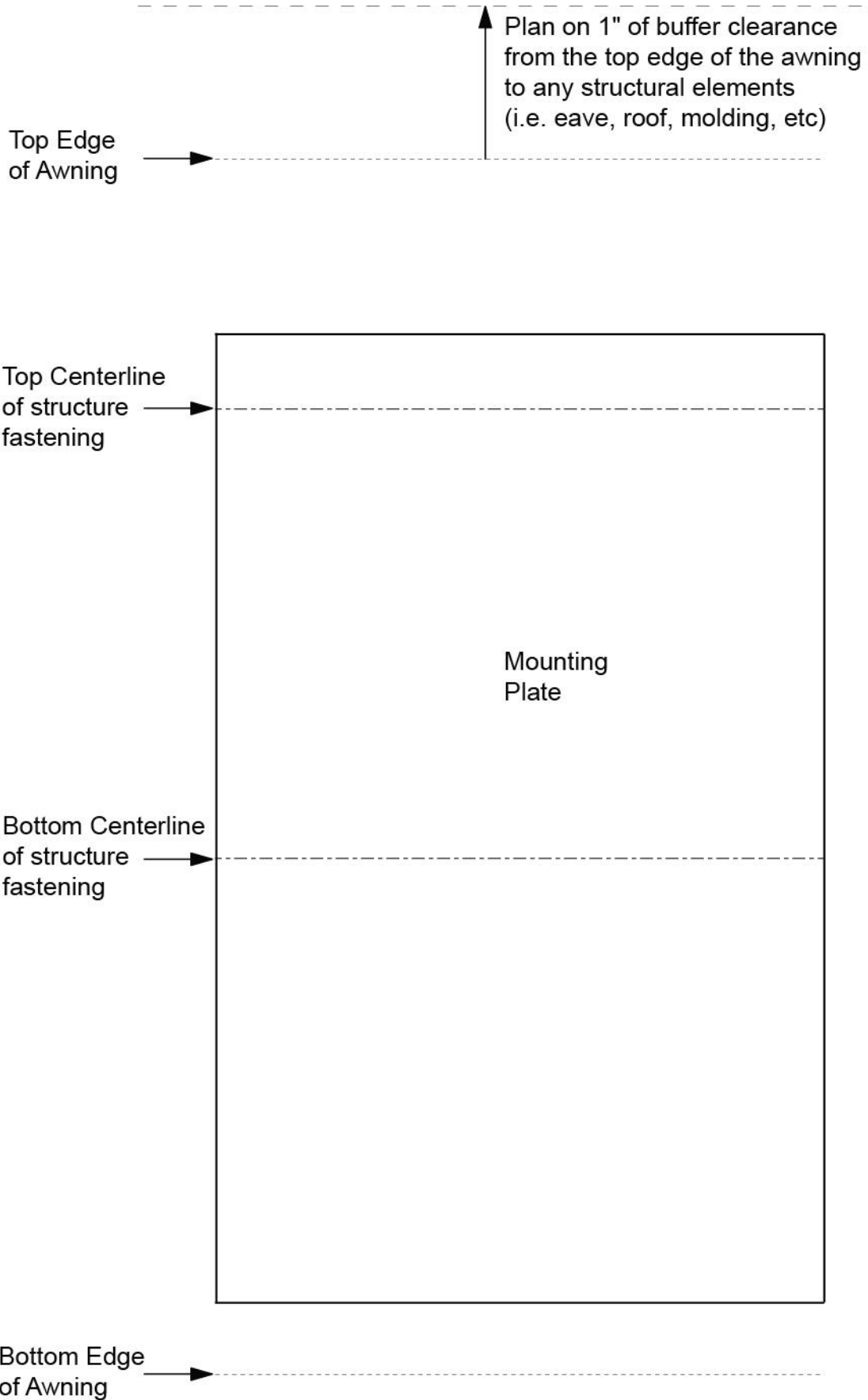

MR005